



CopperCreek
H A R D W A R E

*Forging “Style” and “Value” into
“Quality” Residential Builder’s Hardware*

**Architectural Guide
January 2006**

	<u>PAGE</u>
1.0 EP Series Locksets	
1.1 Knobs	04
1.2 Levers	08
1.3 Deadbolts	12
1.4 Solid Brass Handlesets	14
2.0 PP Series Locksets	
2.1 Knobs	16
2.2 Solid Brass Deadbolts	18
2.4 Solid Brass Handlesets	20
3.0 Light Commercial Locksets	
3.1 BHMA Grade-1 Commercial Levers	24
3.2 BHMA Grade-2 Commercial Levers	26
3.3 BHMA Grade-1 & Grade-2 Deadbolts	28
3.4 BHMA Grade-2 Interconnected Levers	30
4.0 General Information	
4.1 Strikes	32
4.2 How To Order	33
4.3 Warranty Information	35
5.0 Specification Submittal Sheets	36



**Ball Knob
(BK)**







**Colonial Knob
(BK)**

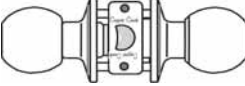

**Egg Knob
(BK)**

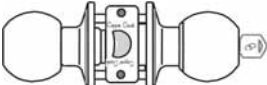
Finish Options:		BHMA Finish	Ball Knob	Colonial Knob	Egg Knob
Polished Brass	PB	605	X	X	X
Antique Brass	AB	609	X		
Satin Stainless	SS	630	X	X	X
Polished Stainless	PS	629	X	X	X
Antique Nickel	AN	620	X	X	X
Pewter	PW	569	X		
Tuscan Bronze	TB	573	X		X
Black	BC	563		X	X

EP Series Specifications		
	2020-Passage	Both knobs always free turning to retract latch. No locking operation.
	2030-Privacy	Inside turn-piece locks or unlocks both knobs. Knob can be unlocked by rotating the outside privacy mechanism.
	2040-Entry	Outside key or inside turn-piece locks or unlocks both knobs.
	2050-Storeroom	Inside knob is free turning. Outside knob is always locked and can only be unlocked with the key inserted & turned.
	2090-Dummy	No Operation. Used as pull or decorative trim only.

EP-Series Specifications	
Latches	Steel adjustable Round Corner standard (RCAL) 1" x 2-1/4", Square Corner (SCAL) and Drive-in (RFL) optional.
Strikes	Full Lip Round Corner standard (RCS) (Others available see parts page 31).
Cylinder	Solid Brass 5 pin plug, with KW1 Keyway.
Door Prep	1" Edge Bore, 1" x 2-1/4" Latch mortise, 2-1/8" cross bore on face of door.
Door Thickness	Minimum 1-3/8", maximum 1-3/4" door thickness.
Handing	All EP-Series knobs are non-handed operation.
U.L.	Available U.L. latch (PT-ULKT02). Allows any EP knob to meet 20 minute, 45 minute, or 90 minute requirements.

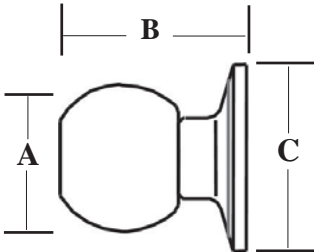
EP-Series Dimensions				
		A	B	C
	Ball Knob	1-15/16"	2-3/8"	2-9/16"
	Colonial Knob	2-3/16"	2-3/8"	2-9/16"
	Egg Knob	2-7/16"	2-3/8"	2-9/16"





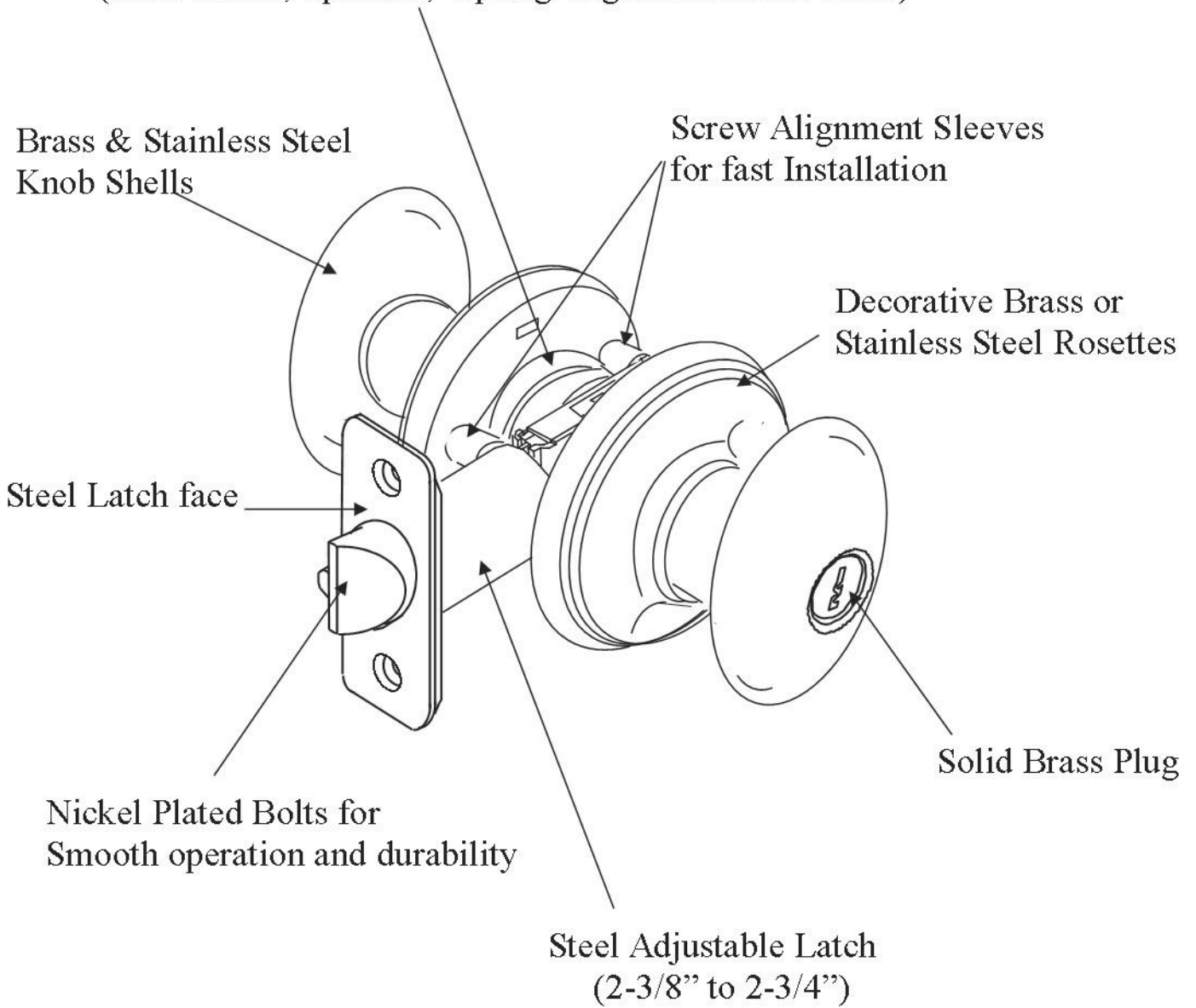

Durable “Steel” Chassis Components
(Rose Liners, Spindles, Spring Cages and Screw Posts)



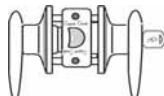

Finish Options:		BHMA Finish	Avery	Jayne	Braxton	Hailey	Waverlie	Classic
Polished Brass	PB	605	X	X	X	X	X	X
Antique Brass	AB	609	X	X	X			
Satin Stainless	SS	630	X	X	X	X	X	X
Polished Stainless	PS	629	X	X	X	X	X	X
Antique Nickel	AN	620		X	X	X	X	
Pewter	PW	569			X	X	X	
Tuscan Bronze	TB	573	X		X	X	X	
Black	BC	563			X		X	

EP-Series Lever Functions

	2220-Passage	Both Levers always free turning to retract latch. No locking operation.
	2230-Privacy	Inside turn-piece locks or unlocks both levers. Lever can be unlocked by rotating the outside privacy mechanism.
	2240-Entry	Outside key or inside turn-piece locks or unlocks both levers.
	2250-Storeroom	Inside lever is free turning. Outside lever is always locked and can only be unlocked with key inserted & turned.
	2290-Dummy	No Operation. Used as pull or decorative trim only.

EP-Series Lever Specifications

Latches	Steel adjustable Round Corner standard (RCAL) 1" x 2-1/4", Square Corner (SCAL), and Drive-in (RFL) optional.
Strikes	Full Lip Round Corner standard RCS. (Others available see parts page 31).
Cylinder	Solid Brass 5 pin plug, with KW1 keyway.
Door Prep	1" Edge Bore, 1" x 2-1/4" Latch mortise, 2-1/8" cross bore on face of door.
Door Thickness	Minimum 1-3/8", maximum 1-3/4" door thickness.
Handing	Waverlie & Classic Levers require Handing (Left or Right) All others are non-handed.
U.L.	Available U.L. latch (PT-ULKT02). Allows any EP lever to meet 20 minute, 45 minute, or 90 minute requirements.

EP-Series Lever Dimensions

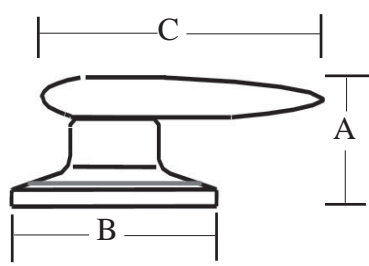
	A	B	C	
	Avery Lever	1-15/16"	2-3/8"	4-9/16"
	Jayne Lever	1-3/16"	2-3/8"	4-9/16"
	Braxton Lever	2-3/8"	2-3/8"	4-9/16"
	Classic Lever	2-7/16"	2-3/8"	4-9/16"
	Waverlie Lever	2-7/16"	2-3/8"	4-9/16"
	Hailey Lever	2-3/8"	2-3/8"	4-9/16"

Durable “Steel” Chassis Components
(Rose Liners, Spindles, Spring Cages and Screw Posts)

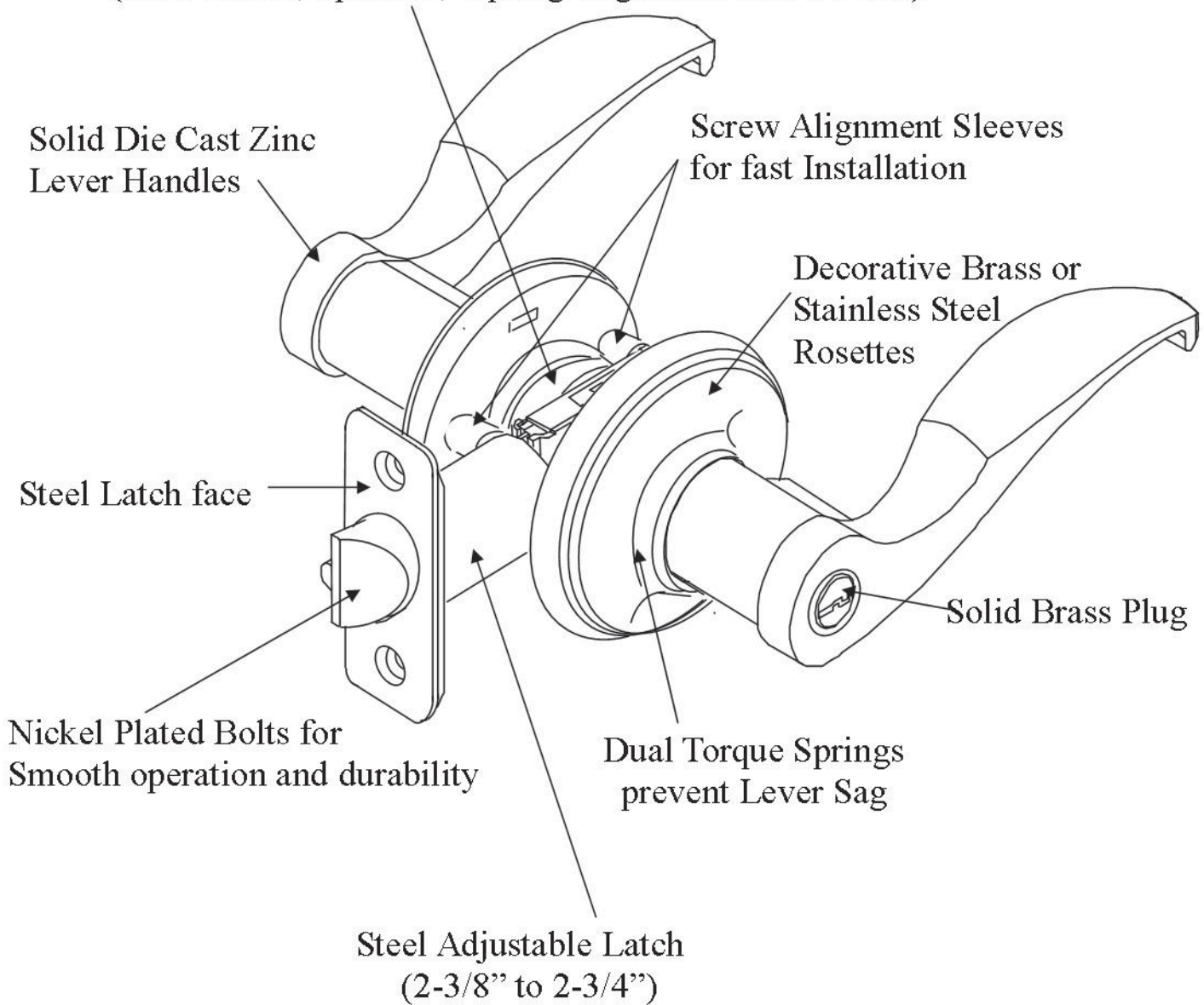



DB2400
 1 sided with backer plate (full bore)



DB2405
 1-Sided 3/4 bore







DB2410
 Single Cylinder

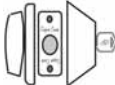

DB2420
 Double Cylinder

Finish Options:		BHMA Finish	DB2400	DB2405	DB2410	DB2420
Polished Brass	PB	605	X	X	X	X
Antique Brass	AB	609			X	X
Satin Stainless	SS	630	X	X	X	X
Polished Stainless	PS	629			X	X
Antique Nickel	AN	620	X	X	X	X
Pewter	PW	569			X	X
Tuscan Bronze	TB	573			X	X
Black	BC	563			X	X

EP-Series Deadbolt Functions		
	2400 - 1 sided Full Bore	Deadbolt thrown by rotating interior turn-piece. non-operable plate on exterior of door (full bore 2-1/8" diameter hole).
	2405 - 1 sided 3/4 Bore	Deadbolt thrown by rotating interior turn-piece. (1/2-3/4 depth bore - 1-5/8" or 1-3/4" hole diameter).
	2410 Single Cylinder	Deadbolt thrown by rotating interior turn-piece or exterior key.
	2420 Double Cylinder	Deadbolt thrown by rotating interior or exterior key.

EP-Series Deadbolt Specifications	
Latches	Steel adjustable Round Corner standard (RCAL) 1" x 2-1/4", Square Corner (SCAL) and Drive-in (RFL) optional.
Strikes	Standard 1" X 2-1/4" RCS & Full Lip 2-1/4" RCS included. Others available (See parts page 31).
Cylinder	Solid Brass 5 pin plug, with KW1 keyway.
Door Prep	2405: 1" Edge Bore, 1"x2-1/4" latch mortise, 1-5/8 to 1-3/4" cross bore (drilled 3/4 bore max). 2400, 2410, 2420: 1" Edge Bore, 1" x 2-1/4" Latch mortise, 2-1/8" cross bore on face of door.
Door Thickness	Minimum 1-3/8", maximum 1-3/4" door thickness.
Handing	All EP-Series deadbolts are non-handed operation.
U.L.	Available U.L. latch (PT-ULKT04). Allows any EP deadbolt to meet 20 minute, 45 minute, or 90 minute requirements.

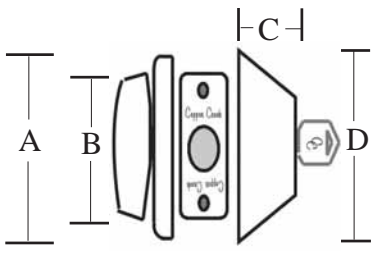
EP-Series Deadbolt Dimensions				
	A	B	C	D
	2400	2-1/2"	2.0"	n/a
	2405	2-1/2"	2.0"	n/a
	2410	2-1/2"	15/16"	2-1/2"
	2420	2-1/2"	n/a	2-9/16"



(CH)
Colonial
Handleset



(HH)
Heritage
Handleset

Finish Options:		BHMA Finish	Colonial	Heritage
Lifetime Brass	PVD	505	X	X
Polished Brass	PB	605	X	X
Antique Brass	AB	609	X	
Satin Stainless	SS	630	X	X
Polished Stainless	PS	629	X	X
Antique Nickel	AN	620	X	X
Pewter	PW	569	X	X
Tuscan Bronze	TB	573	X	X
Black	BC	563	X	X

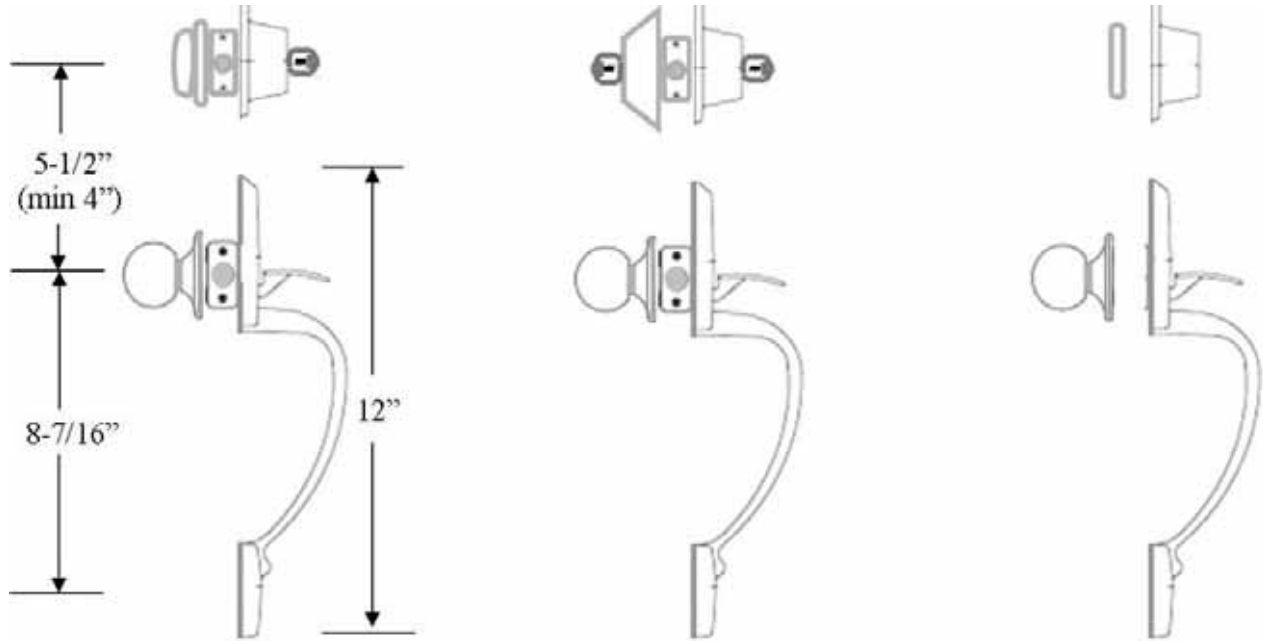

2610

SINGLE CYLINDER FUNCTION

Deadbolt thrown by rotating interior turn-piece or exterior key. Plain-latch retracted by interior knob/lever or exterior thumb piece.

2620

DOUBLE CYL. FUNCTION

Deadbolt thrown by rotating interior or exterior key. Plain-latch retracted by interior knob/lever or exterior thumb piece.

2690

DUMMY FUNCTION

Non-active function. Exterior grip handle and interior knob/lever act as pull only.

EP-Series Handleset Specifications

Latches	Steel adjustable Round Corner standard (RCAL) 1" x 2-1/4", Square Corner (SCAL) and Drive-in (RFL) optional.
Strikes	Full Lip Round Corner standard (RCS) . Others available (see parts page 31).
Cylinder	Solid Brass Cylinder and Solid Brass 5 pin plug, with KW1 keyway.
Door Prep	1" Edge Bore, 1" x 2-1/4" Latch mortise, 2-1/8" cross bore on face of door. Deadbolt and Plain-Latches on 5-1/2" spacing (center to center).
Door Thickness	Minimum 1-5/8", maximum 1-3/4" door thickness.
Handing	All EP-Series handlesets are non-handed operation. Interior assemblies for Waverlie Lever and Classic Lever are handed (LH or RH).
U.L.	EP Handlesets are not available to meet U.L. fire ratings.







**Premium Series
HK4000
Heritage Knob**

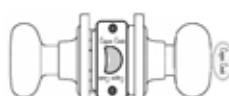

- *Concealed Screws*
- *Anti-Pry Shield*
- *Meets BHMA Grade-2 - 400,000 cycle test.*
- *Larger Decorative Rose*
- *Solid Brass or Stainless Steel Knob and Rose*
- *Solid Brass Cylinder Plug*
- *Steel Latch and latch-face*
- *Nickel Plated bolt*
- *Large Bow - nickel plated key*

Finish Options:		BHMA Finish	Heritage Knob
Polished Brass	PB	605	X
Antique Brass	AB	609	
Satin Stainless	SS	630	X
Polished Stainless	PS	629	X
Antique Nickel	AN	620	X
Pewter	PW	569	X
Tuscan Bronze	TB	573	X
Black	BC	563	

PP Heritage Knob Functions		
	4020-Passage	Both knobs always free turning to retract latch. No locking operation.
	4030-Privacy	Inside turn-piece locks or unlocks both knobs. Knob also unlocked by rotating the outside privacy mechanism.
	4040-Entry	Outside key or inside turn-piece locks or unlocks both knobs.
	4050-Storeroom	Inside knob is free turning. Outside knob is always locked and can only be unlocked with key inserted & turned.
	4090-Dummy	No Operation. Used as pull or decorative trim only.

PP Heritage Knob Specifications	
Latches	Steel adjustable Round Corner standard (RCAL) 1" x 2-1/4", Square Corner (SCAL) and Drive-in (RFL) optional.
Strikes	Full Lip Round Corner standard (RCS) Square Corner Optional
Cylinder	Solid Brass 5 pin plug, with KW1 keyway.
Door Prep	1" Edge Bore, 1" x 2-1/4" Latch mortise, 2-1/8" cross bore on face of door.
Door Thickness	Minimum 1-3/8", maximum 1-3/4" door thickness.
Handing	All HK knobs are non-handed operation.
U.L.	Available U.L. latch (PT-ULKT02). Allows any EP knob to meet 20 minute, 45 minute, or 90 minute requirements.

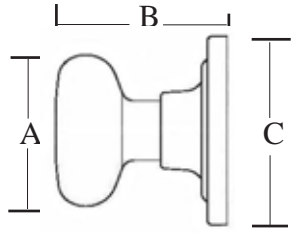
PP Heritage Knob Dimensions			
	A	B	C
	2-1/4"	2-5/16"	2-3/4"

**Premium Series
DB4400 “Solid Brass”
Deadbolt**



- *Concealed Screws.*
- *Snap On Designer Interior Turn Piece.*
- *Elegant Interior Rosette.*
- *Solid Brass Cylinder Guard.*
- *Solid Brass Cylinder & Plug.*
- *Steel Latch and latch-face.*
- *Nickel Plated bolts.*
- *Large Bow - Nickel plated key*
- *Designed for 1-3/4” thick Doors*

Finish Options:		BHMA Finish	Single Cylinder	Double Cylinder
Lifetime Brass	PVD	505	X	X
Antique Brass	AB	609		
Satin Stainless	SS	630	X	X
Polished Stainless	PS	629	X	X
Antique Nickel	AN	620	X	X
Pewter	PW	569	X	X
Tuscan Bronze	TB	573	X	X
Black	BC	563	X	X

PP Deadbolt Functions

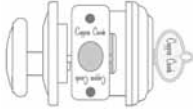

4410 - Single Cylinder

Deadbolt thrown by rotating interior turn-piece or exterior key.



4420 - Double Cylinder

Deadbolt thrown by rotating interior or exterior key.

PP Series Solid Brass Deadbolt Specifications

Latches	Steel adjustable Round Corner standard (RCAL) 1" x 2-1/4", Square Corner (SCAL) and Drive-in (RFL) optional.
Strikes	Standard 1" X 2-1/4" RCS & Full Lip 2-1/4" RCS. Others available (See parts page 31).
Cylinder	Solid Brass 5 pin plug, with KW1 keyway.
Door Prep	1" Edge Bore, 1" x 2-1/4" Latch mortise, 2-1/8" cross bore on face of door.
Door Thickness	Designed for 1-3/4" doors. Minimum 1-11/16", maximum 1-7/8" door thickness.
Handing	All PP-Series deadbolts are non-handed operation.
U.L.	Available U.L. latch (PT-ULKT04). Allows any EP deadbolt to meet 20 minute, 45 minute, or 90 minute requirements.

PP Series Solid Brass Deadbolt Dimensions

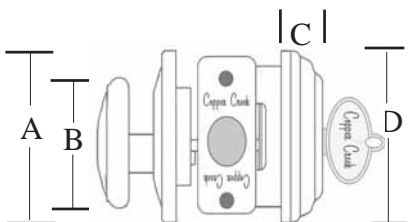

	A	B	C	D
4410	2-9/16"	1-15/16"	15/16"	2-9/16"
4420	2-9/16"	n/a	15/16"	2-9/16"



(AT)
Ashton
Handleset

(LN)
Lauren
Handleset

Finish Options:		BHMA Finish	Ashton	Lauren
Lifetime Brass	PVD	505	X	X
Satin Stainless	SS	630	X	X
Antique Nickel	AN	620	X	X
Pewter	PW	569	X	X
Tuscan Bronze	TB	573	X	X
Black	BC	563	X	X



(MG)
Morgan
Handleset



(CD)
Chandler
Handleset

Finish Options:		BHMA Finish	Morgan	Chandler
Satin Stainless	SS	630	X	X
Polished Stainless	PS	629	X	
Antique Nickel	AN	620	X	X
Pewter	PW	569	X	X
Tuscan Bronze	TB	573	X	X
Black	BC	563	X	X

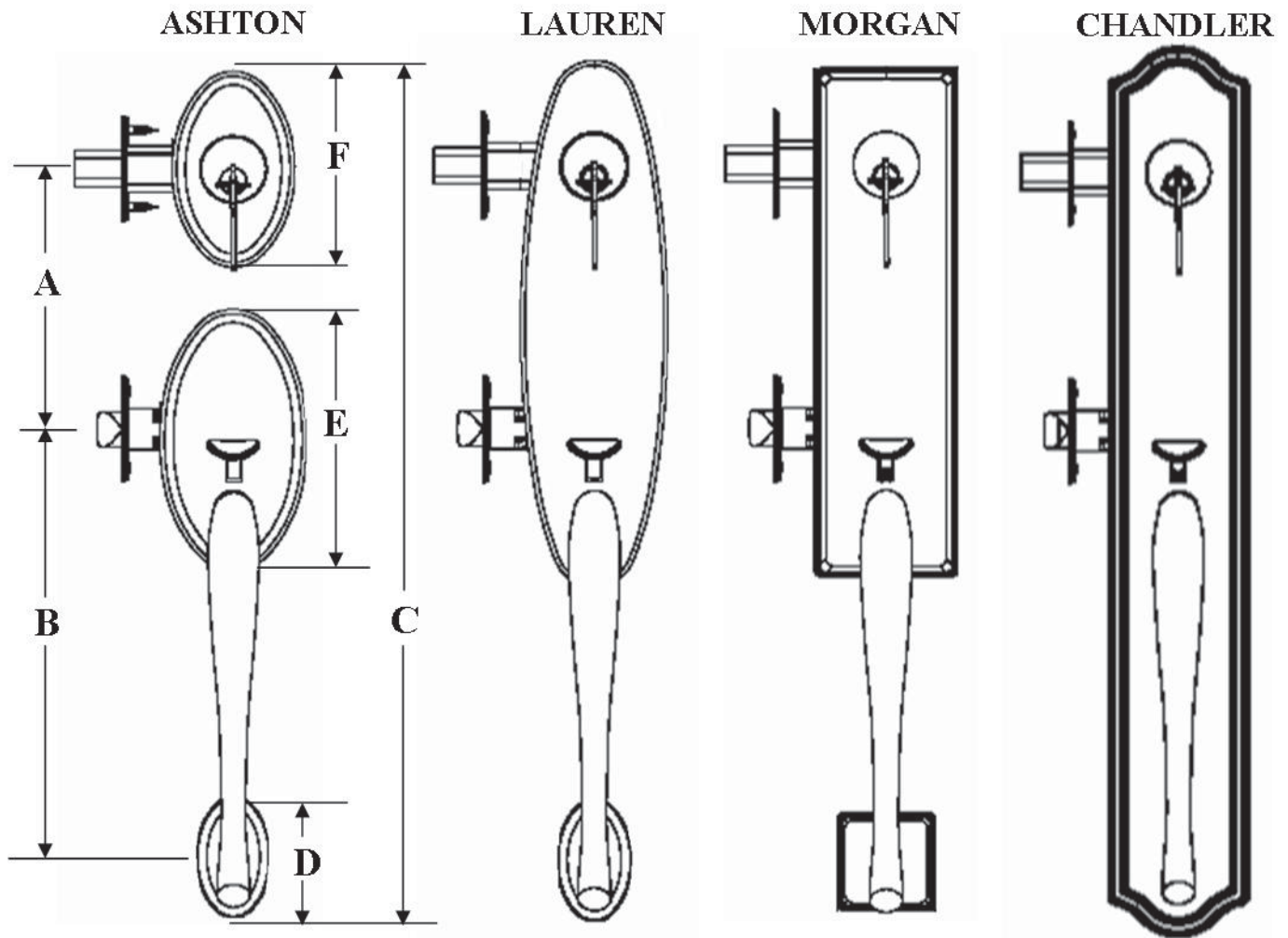

		Ashton	Lauren	Morgan	Chandler
A	Cross Bores on Center	5-1/2"	5-1/2"	5-1/2"	5-1/2"
B	Cross Bore to Sexnut on Center	9-1/16"	9-1/16"	9-1/16"	9-1/16"
C	Overall Handleset Height	18"	18"	17-5/8"	19"
D	Lower Rose Height	2-9/16"	2-9/16"	2"	n/a
	Lower Rose Width	1-9/16"	1-9/16"	2"	n/a
E	Main Escutcheon Height	5-1/2"	11"	10-5/8"	19"
	Main Escutcheon Width	3-1/8"	3-1/8"	3"	3"
F	Deadbolt Rose Height	4-1/8"	n/a	n/a	n/a
	Deadbolt Rose Width	2-9/16"	n/a	n/a	n/a



4610

SINGLE CYLINDER FUNCTION

Deadbolt thrown by rotating interior turn-piece or exterior key. Plain-latch retracted by interior knob/lever or exterior thumb piece.



4620

DOUBLE CYL. FUNCTION

Deadbolt thrown by rotating interior or exterior key. Plain-latch retracted by interior knob/lever or exterior thumb piece.

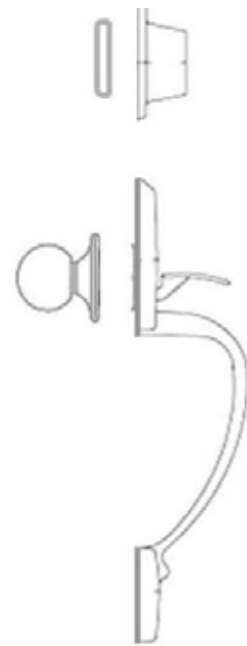

4690

DUMMY FUNCTION

Non-active function. Exterior grip handle and interior knob/lever act as pull only.

PP-Series Handleset Specifications	
Latches	Steel adjustable Round Corner standard (RCAL) 1" x 2-1/4", Square Corner (SCAL) and Drive-in (RFL) optional.
Strikes	Full Lip Round Corner standard (RCS) . Others available (see parts page 31).
Cylinder	Solid Brass Cylinder and Solid Brass 5 pin plug, with KW1 keyway.
Door Prep	1" Edge Bore, 1" x 2-1/4" Latch mortise, 2-1/8" cross bore on face of door. Deadbolt and Plain-Latches on 5-1/2" spacing (center to center).
Door Thickness	Minimum 1-5/8", maximum 1-3/4" door thickness.
Handing	All PP-Series handlesets are non-handed operation. Interior assemblies for Waverlie Lever and Classic Lever are handed (LH or RH).
U.L.	PP Handlesets are not available to meet U.L. fire ratings.





**7200 SERIES
BHMA GRADE-1
COMMERCIAL LEVER**

Finish Options:		BHMA Finish	Grade 1 Lever
Polished Brass	PB	605	X
Satin Stainless	SS	630	X
Polished Stainless	**PS	629	X
Antique Nickel	**AN	620	X
Oil Rubbed Bronze	**10B	573	X

**** Special Order Finishes (PS, AN, 10B,) require extra factory lead-times. Call for details**

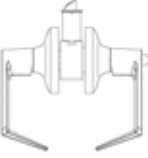
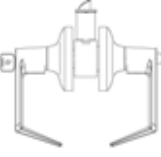
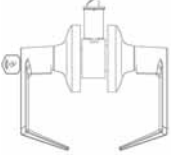
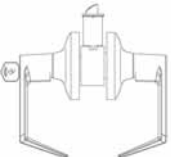
LT 7200 Series Lever Functions

	7220 Passage	Both Levers always free turning to retract latch. No locking operation.
	7231 Restroom	Inside push-button locks or unlocks both levers. Lever can be unlocked by rotating the outside privacy mechanism. Lever is unlocked by rotating interior lever or by closing door.
	7241 Entry/Office	Key or inside push button locks both levers. Turning inside lever or key unlocks both levers. "Pushing & Turning" inside push button activates "Storeroom/office function".
	7250 Storeroom	Inside lever is free turning. Outside lever is always locked and can only be unlocked with key inserted & turned.
	7260 Classroom	Outside lever locked or unlocked with key. Inside is always free.
	7290 1/2-Dummy	No Operation. Used as pull or decorative trim only.

LT 7200 Series Specifications

Clutch	Standard on Keyed & Restroom Functions.
Thru-Bolt	2 standard; removable if not desired.
Latches	Solid Stainless Steel Bolt. 1-1/8" Wide Square Corner. 2-3/4" backset standard, 2-3/8" optional.
Strikes	4-7/8" ASA Standard. 2-3/4" T-Strike Optional.
Cylinder	6 pin Schlage -C standard. KW1 6-pin optional.
Door Prep	1" edge Bore, 1"-1/8" x 2-1/4" Latch mortise, 2-1/8" cross bore .
Door Thickness	Minimum 1-3/8", maximum 1-3/4" door thickness.
Handing	All LT-7200-Series Levers are non-handed operation.
U.L.	Standard 3 hour U.L. Fire Rated.
BHMA	Meets ANSI/BHMA 156.2 Grade-1 800,000 cycles.

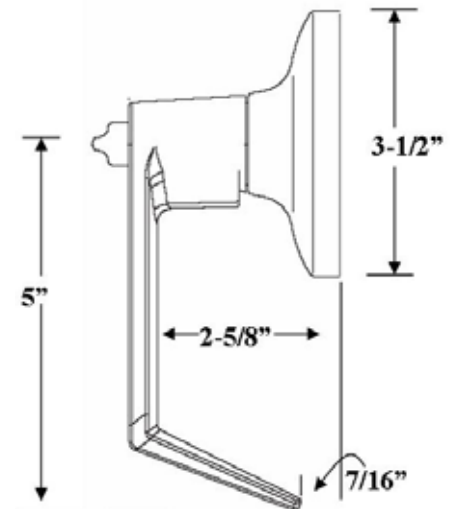





**6200 SERIES
BHMA GRADE-2
COMMERCIAL LEVER**

Finish Options:		BHMA Finish	Grade 2 Lever
Polished Brass	PB	605	X
Satin Stainless	SS	630	X
Polished Stainless	**PS	629	X
Antique Nickel	**AN	620	X
Oil Rubbed Bronze	**10B	573	X

**** Special Order Finishes (PS, AN, 10B,) require extra factory lead-times. Call for details**

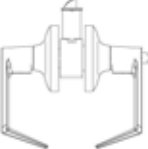
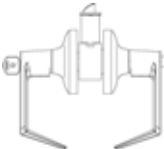
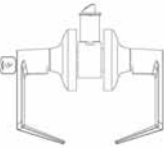
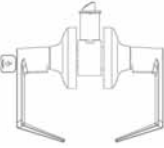
LT 6200 Series Lever Functions

	6220 Passage	Both Levers always free turning to retract latch. No locking operation.
	6231 Restroom	Inside push-button locks or unlocks both levers. Lever can be unlocked by rotating the outside privacy mechanism. Lever is unlocked by rotating interior lever or by closing door.
	6241 Entry/Office	Key or inside push button locks both levers. Turning inside lever or key unlocks both levers. "Pushing & Turning" inside push button activates "Storeroom/office function".
	6250 Storeroom	Inside lever is free turning. Outside lever is always locked and can only be unlocked with key inserted & turned.
	6260 Classroom	Outside lever locked or unlocked with key. Inside is always free.
	6290 1/2 Dummy	No Operation. Used as pull or decorative trim only.

LT 6200 Series Specifications

Clutch	Standard on Keyed & Restroom Functions.
Thru-Bolt	2 standard; removable if not desired.
Latches	Solid Stainless Steel Bolt. 1" wide Square Corner. 2-3/4" backset standard, 2-3/8" optional.
Strikes	2-3/4" T-Strike Standard, 4-7/8" ASA Optional.
Cylinder	6 pin Schlage -C standard. KW1 6-pin optional.
Door Prep	1" edge Bore, 1"-1/8" x 2-1/4" Latch mortise, 2-1/8" cross bore .
Door Thickness	Minimum 1-3/8", maximum 1-3/4" door thickness.
Handing	All LT6200-Series Levers are non-handed operation.
U.L.	Standard 3 hour U.L. Fire Rated.
BHMA	Meets ANSI/BHMA 156.2 Grade-2 ; 400,000 cycles.

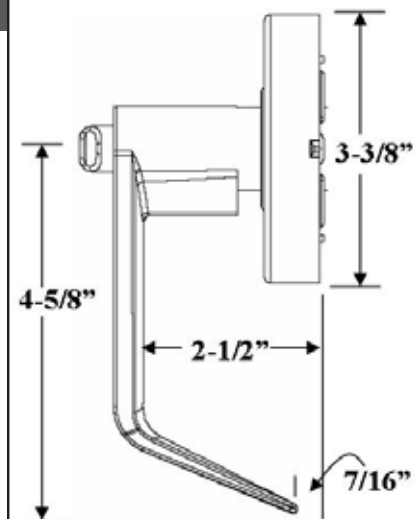



“6410 Grade-2” & “7410 Grade-1” Single Cylinder Deadbolts

DB6410 - Meets Grade-2; 400,000 Cycles.

DB7410 - Meets Grade-1; 800,000 Cycles.
 (solid brass Cylinder Guard - not shown.)

Finish Options:		BHMA Finish	Grade-2 Deadbolt	Grade-1 Deadbolt
Polished Brass	PB	605	X	X
Satin Stainless	SS	630	X	X
Antique Brass	**AB	609	X	X
Polished Stainless	**PS	629	X	X
Antique Nickel	**AN	620	X	X
Oil Rubbed Bronze	**10B	573	X	X

**** Special Order Finishes (AB, PS, AN, 10B,) require extra factory lead-times. Call for details**

LT-Series Deadbolt Functions

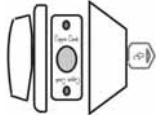
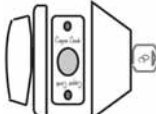
	<p>6410 Single Cylinder</p>	<p>BHMA Grade-2, standard U.L.. Deadbolt is thrown by rotating interior ADA turn-piece or exterior key.</p>
	<p>7410 Single Cylinder</p>	<p>Solid Brass BHMA Grade-1, standard U.L.. Deadbolt is thrown by rotating interior ADA turn-piece or exterior key.</p>

LT-Series Deadbolt Specifications

Latches	U.L. Steel 2-3/8" Round Corner standard (RCAL) 1" x 2-1/4", Square Corner (SCAL) and Drive-in (RFL) optional. 2-3.4" backset optional.
Strikes	Standard 1-1/8" X 2-1/4" RCS strike. Others available (See parts page 31).
Cylinder	Solid Brass Schlage C 6 pin standard. 6 pin KW1 optional.
Door Prep	1" Edge Bore, 1" x 2-1/4" Latch mortise, 2-1/8" cross bore on face of door.
Door Thickness	Minimum 1-3/8", maximum 1-3/4" door thickness.
Handing	All LT-Series deadbolts are non-handed operation.
U.L.	Standard 3 hour UL

EP-Series Deadbolt Dimensions

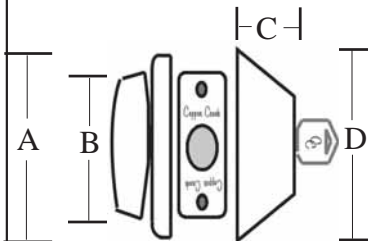
	A	B	C	D
6410	2-9/16"	1-15/16"	1-1/16"	2-9/16"
7410	2-1/2"	1-15/16"	1"	2-1/2"



**6900 SERIES
BHMA GRADE-2
INTERCONNECTED
LOCKSET**

Finish Options:		BHMA Finish	Interconnected Lever
Polished Brass	PB	605	X
Satin Stainless	SS	630	X
Polished Stainless	**PS	629	X
Antique Nickel	**AN	620	X
Oil Rubbed Bronze	**10B	573	X

**** Special Order Finishes (PS, AN, 10B,) require extra factory lead-times. Call for details**

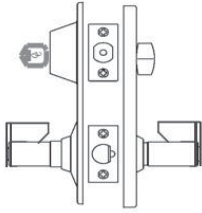
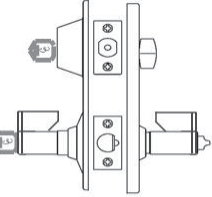

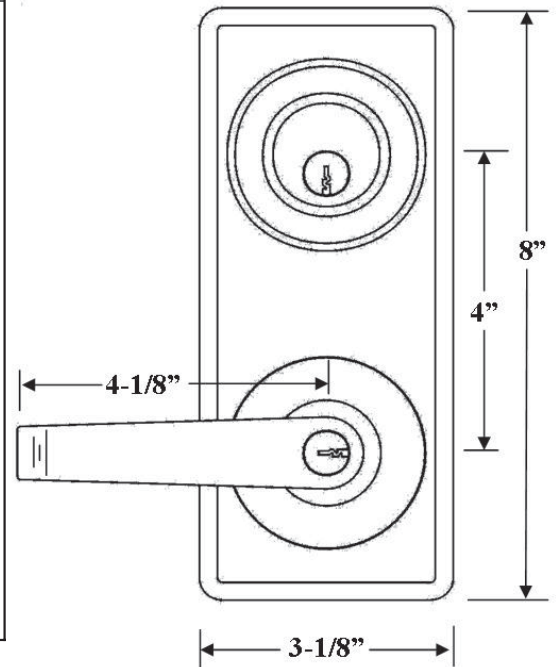

LT-Series Lever Functions		
	<p>6920 Passage Interconnect</p>	<p>Both Levers always free turning to retract latch. Rotating inside lever simultaneously unlocks deadbolt. Deadbolt also unlocked with key or by rotating interior thumb turn.</p>
	<p>6941 Entry/Office Interconnect</p>	<p>Key or inside push button locks both levers. Turning inside lever unlocks both levers and the deadbolt simultaneously. "Pushing & Turning" inside push button activates the "Storeroom function". Deadbolt also locked or unlocked with key or by rotating interior thumb turn.</p>

LT6900-Series Interconnect Specifications	
Latches	Solid Stainless Steel Bolt. 1" wide Round Corner. 2-3/8" backset standard, 2-3/4" Optional.
Strikes	1"x2-3/4" (RCS) for Deadbolt, Full Lip 2-14" for Lever Standard, Other strikes available.
Cylinder	6 pin KW1 -C standard. Schlage-C optional.
Door Prep	1" edge Bore, 1"-1/8" x 2-1/4" Latch mortise, 2-1/8" cross bores 4" center to center.
Door Thickness	Minimum 1-3/8", maximum 1-3/4" door thickness.
Handing	All LT6900-Series Interconnects are non-handed operation.
U.L.	Standard 3 hour U.L. Fire Rated.
BHMA	Meets ANSI/BHMA 156.2 Grade-2 ; 400,000 cycles.
ADA	Full lever return to within 1/2" of door.

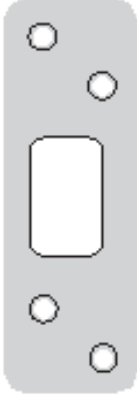
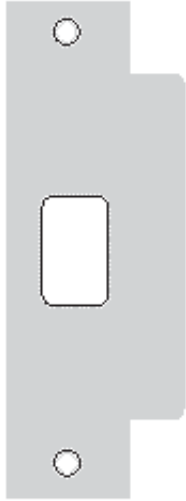

Deadbolt Strikes

Latchbolt Strikes

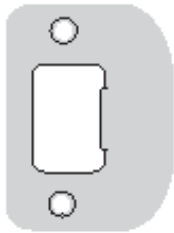
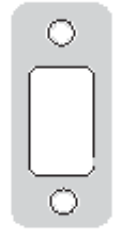
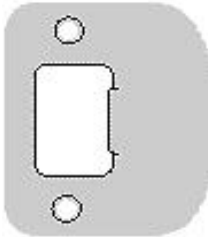
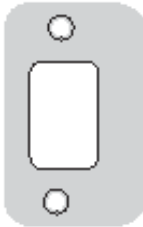
 <p>PT - DS34</p> <ul style="list-style-type: none"> - Round Corner High Security Strike. - 3-5/8" x 1-1/4". - 100 per box. 	 <p>PT - LS22</p> <ul style="list-style-type: none"> - ASA U.L. Strike. - 4-7/8" x 1-1/4". - 100 per box.
 <p>PT - DS06</p> <ul style="list-style-type: none"> - Round Corner Standard Security Strike. - 2-3/4" x 1-1/8". - 100 per box. 	 <p>PT - LS12</p> <ul style="list-style-type: none"> - U.L. T-Strike. - 2-3/4" x 1-1/8". - 100 per box.
 <p>PT - DS02</p> <ul style="list-style-type: none"> - SquareCorner Standard Security Strike. - 2-3/4" x 1-1/8". - 100 per box. 	 <p>PT - LS12 (PT-LS16 U.L.)</p> <ul style="list-style-type: none"> - Standard duty full lip strike. - 2-1/4" x Full Lip". - 100 per box. - \$0.75 each (\$1.40 U.L.)
 <p>PT - DS06</p> <ul style="list-style-type: none"> - Round Corner Standard Security Strike. - 2-1/4" x 1". - 100 per box. 	 <p>PT - LS06E</p> <ul style="list-style-type: none"> - Extended Full Lip Strike. - 2-3/4" x Full Lip - 100 per box.
 <p>PT - DS26</p> <ul style="list-style-type: none"> - Round Corner Full Lip Standard Security Strike. - 2-1/4" x 1" Full Lip. - 100 per box. 	

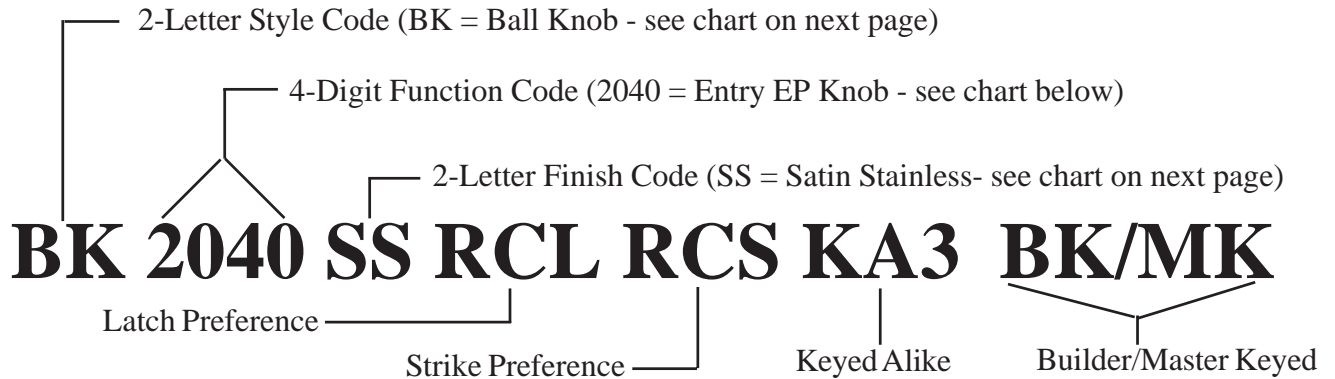

PRODUCT SERIES - FUNCTION CODES

EP SERIES			PP SERIES			LT SERIES		
Category (#)	Function (#)	Function Code	Category (#)	Function (#)	Function Code	Category (#)	Function (#)	Function Code
Knobs (20)	Passage (20)	2020	Knobs (40)	Passage (20)	4020	Interconnect (69)	Passage (20)	6920
	Privacy (30)	2030		Privacy (30)	4030		Entry (41)	6941
	Entry (40)	2040		Entry (40)	4040	Grade 2 Levers (62)	Passage (20)	6220
	Storeroom (50)	2050		Storeroom (50)	4050		Restroom (31)	6231
	Dummy (90)	2090		Dummy (90)	4090		Entry (41)	6241
Levers (22)	Passage (20)	2220	Levers (42)	Passage (20)	4220	Storeroom (50)	6250	
	Privacy (30)	2230		Privacy (30)	4230	Classroom (60)	6260	
	Entry (40)	2240		Entry (40)	4240	Grade 1 Levers (72)	Passage (20)	7220
	Storeroom (50)	2250		Storeroom (50)	4250		Restroom (31)	7231
	Dummy (90)	2290		Dummy (90)	4290		Entry (41)	7241
Deadbolts (24)	1-Sided (00)	2400	Deadbolts (44)	Sgl. Cylinder (10)	4410		Storeroom (50)	7250
	Sgl. Cylinder (10)	2410		Dbl. Cylinder (20)	4420	Classroom (60)	7260	
	Dbl. Cylinder (20)	2420	Handlesets (46)	Active (10)	4610	Grade 1 Deadbolt (74)	Sgl. Cylinder (10)	7410
Handlesets (26)	Active (10)	2610		Dummy (90)	4690	Grade 2 Deadbolt (64)	Sgl. Cylinder (10)	6410
	Dummy (90)	2690	Interior Assemblies (48)	Sgl. Cylinder (10)	4810			
Interior Assemblies (28)	Sgl. Cylinder (10)	2810		Dummy (90)	4890			
	Dummy (90)	2890						

PRODUCT SERIES - STYLE CODES

EP SERIES			PP SERIES			LT SERIES		
Category(#)	Style	Style Code	Category(#)	Style	Style Code	Category(#)	Style	Style Code
Knobs (20)	Ball	BK	Knobs (40)	Heritage	HK	Interconnect (69)	Avery	AL
	Colonial	CK	Levers (42)	TBD	-	Grade 1 Lever (72)	Avery	AL
	Egg	EK	Deadbolts (44)	Deadbolt	DB	Grade2 Levers (62)	Avery	AL
Levers (22)	Avery	AL	Handlesets (46)	Ashton	AT	Grade-1 Deadbolts (74)	Deadbolt	DB
	Jayne	JL		Lauren	LN	Grade-2 Deadbolts (64)	Deadbolt	DB
	Braxton	BL		Morgan	MG			
	Hailey	HL		Chandler	CD			
	Classic	CL						
	Waverlie	WL						
Deadbolts (24)	Deadbolt	DB						
Handlesets (26)	Colonial	CH						
	Heritage	HH						

FINISH CODES CHART

Copper Creek Finishes	Copper Creek Finish Code	US Code	BHMA
Polished Brass	PB	US3	605
Lifetime Brass	PVD	L03	505
Antique Brass	AB	US5	609
Satin Stainless	SS	US32D / US15	630 / 619
Polished Stainless	PS	US26	625
Antique Nickel	AN	US15A	620
Black	BC	-	563
Tuscan Bronze	TB	11P	573
Pewter	PW	-	569

Mechanical Warranty

EP & PP SERIES: Copper Creek (CCI) offers a Lifetime Mechanical warranty to the original residential user where the locksets are first installed, as long as the original user occupies that residence.

LT SERIES: CCI offers a 1 year Mechanical warranty to the original residential user where the locksets are first installed, as long as the original user occupies that residence.

The Warranty covers mechanical defects in material and workmanship. The Warranty does not cover misuse, abuse, finish defects, or any lockset installed in a non-residential dwelling/building.

CCI will not be held liable for any and all indirect or incidental costs, punitive or consequential damages, arising from the sale, abuse or misuse of Copper Creek Locksets.

Finish Warranty:

EP SERIES: CCI offers a 5 year finish warranty on all Standard & Distressed finishes extended to a 25 year finish warranty for PVD (L03) finish.

PP SERIES: CCI offers a 10 year finish warranty on all Standard & Distressed finishes extended to a 25 year finish warranty for PVD (L03) finish.

LT SERIES: CCI offers a 1 year finish warranty on all finishes where the locksets are installed in a residential dwelling/building.

These finish warranties are to the original residential user where locksets are first installed, as long as the original user occupies that residence. The Warranty covers tarnish from natural environmental elements including sun light, salt air, and humidity. The Warranty does not cover damages from paints, cleaners, chemicals, scratches, abrasions, or installations in a non-residential buildings.

CCI will not be held liable for any and all indirect or incidental costs, punitive or consequential damages, arising from the sale, abuse or misuse of Copper Creek Locksets.

Additional Warranty Terms, Conditions, and Claims

- The purchaser of any Copper Creek lockset agrees to the following additional terms and conditions.
- Copper Creek makes no other warranty, either expressed or implied, other than the above stated Mechanical and finish warranties.
- CCI's maximum liability is limited to the original purchase price of the locksets.
- CCI is not responsible or liable for changes or alterations to products by any 3rd party.
- CCI reserves the right to make improvements or changes to the specifications and designs of our products without obligation to incorporate those improvements or changes on previously manufactured products.
- All warranty claims must be made in writing or by telephone directly to Copper Creek Inc from the original purchaser or customer where the locks were first sold to validate the claim.
- Once the Locksets are returned, CCI will either repair, replace or refund the original price of the lockset to the original purchaser.
- All freight to return and/or re-ship replacement/repaired locksets is the responsibility of the original purchaser.

Builder / Developer: _____
Architect: _____
Project Name: _____
Model: _____

Handleset:

CH HH AT
 LN MG CD

Finish:

PB AB PS SS AN PW TB BC
 PVD



Interior Knob Style

BK CK EK HK

Finish:

PB AB PS SS AN PW TB BC



Interior Lever Style

HL JL BL WL CL

Finish:

PB AB PS SS AN PW TB BC



Deadbolt Style

EP SERIES PP SERIES

Finish:

PB AB PS SS AN PW TB BC



Finish Descriptions

PVD - Lifetime Brass AB - Antique Brass PS - Polished Stainless PW - Pewter TB - Tuscan Bronze
 PB - Polished Brass AN - Antique Nickel SS - Satin Stainless BC - Black

Builder / Developer: _____
Architect: _____
Project Name: _____
Model: _____

Interconnected Lockset:

1 Point Locking (6920)

2 Point Locking (6941)

Finish:

PB PS SS AN 10B



**AL (Avery Lever)
6900 Series**

Grade-2 Commercial Lever:

Finish:

PB PS SS AN 10B



**AL (Avery Lever)
6200 Series**

Grade-1 Commercial Lever:

Finish:

PB PS SS AN 10B



**AL (Avery Lever)
7200 Series**

Grade - 2 Commercial Deadbolt

Grade - 1 Commercial Deadbolt

Finish:

PB PS SS AN 10B



DB 6241 Grade-2

DB7241 Grade-1

Finish Descriptions

PB - Polished Brass PS - Polished Stainless SS - Satin Stainless AN - Antique Nickel 10B - Oil Rubbed Bronze



9073 Pulsar Court

Suite A

Corona, CA 92883

(951) 277-8901 main office telephone

(888) 492-9080 "toll free"

(951) 277-8911 fax

www.coppercreekhardware.com

email: sales@coppercreekhardware.com